

# HARKEN®

USA – Tel: (+1) 262-691-3320 • Web: [www.harken.com](http://www.harken.com) • Email: [harken@harken.com](mailto:harken@harken.com)

Italy – Tel: (+39) 031.3523511 • Web: [www.harken.it](http://www.harken.it) • Email: [techservice@harken.it](mailto:techservice@harken.it)

## INSTRUCTIONS

### Midrange Windward Sheeting Cars

1635, 1636, 1637 (1637 Kit only fits 1624/1625 cars – not designed for T27 cars)



**WARNING!** Strictly follow all instructions to avoid an accident, damage to your vessel, personal injury, or death. See [www.harken.com/manuals](http://www.harken.com/manuals) for additional safety information.

**IMPORTANT!** See Inspection and Maintenance at end of manual.

### Terms

**Windward sheeting** – Mainsheet force on slider assembly opens leeward cleat for one (1) step trimming car to windward.

**CB** – Captive bearings. Wire retaining clips hold bearings captive for easy loading onto track and for maintenance.

**CB+ cars** – Cars that can convert to old style non-CB track.

**Corner keepers** – Used on CB+ cars to help retain balls when cars are off track. Introduced beginning of 2015.

**Retaining clips** – Formed wires for holding bearings.

**CB style track** – Track designed with deeper grooves to accept CB car retaining clips.

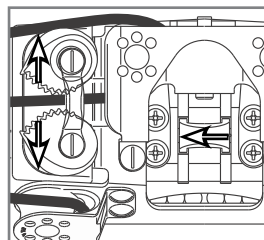

### CB+ Car Underside

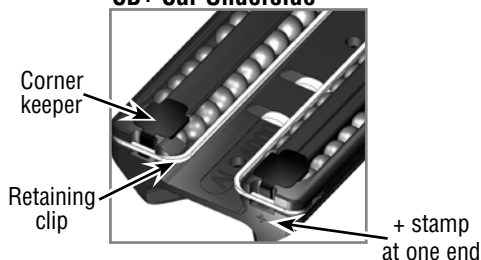

### Specifications

Car	Description	Car width		Car length		Maximum working load		Breaking load	
		in	mm	in	mm	lb	kg	lb	kg
1635	Midrange CB	4 <sup>1</sup> / <sub>8</sub>	105	4 <sup>1</sup> / <sub>4</sub>	108	1800	816	5000	2268
1636	Midrange CB/high-load	4 <sup>1</sup> / <sub>8</sub>	105	5 <sup>3</sup> / <sub>16</sub>	132	2300	1043	5000	2268

### Track Compatibility

#### CB Track

Car	A		B		C	
	in	mm	in	mm	in	mm
1602, R27	1 <sup>1</sup> / <sub>16</sub>	27	9 <sup>1</sup> / <sub>16</sub>	14	1	25
R27HB	1 <sup>1</sup> / <sub>16</sub>	27	1 <sup>5</sup> / <sub>8</sub>	42	1 <sup>1</sup> / <sub>32</sub>	31

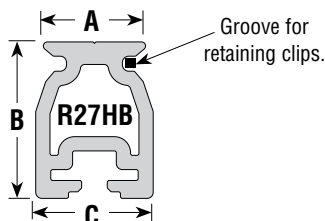
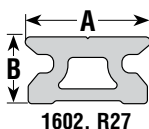

CB cars are shipped for use on CB track with grooves at waist to accept retaining clips first supplied by Harken in 2003. See end of manual if you have older track.

## Mounting Windward Car Assembly 1635 and 1636

1. Butt car against track so angled sheaves face forward toward bow.
2. Slide car onto track.

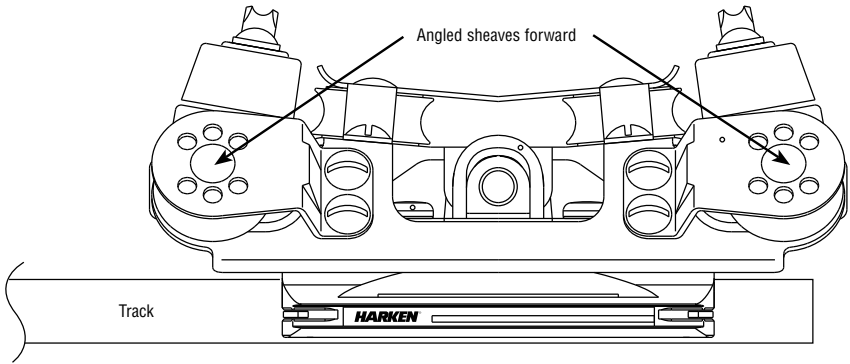

## End Controls

For a 3:1 or 4:1 traveler control, use a Harken Midrange E2730 or 1631 single sheave end control at each end of track.

### Reeving 3:1 End Control

1. Use 8 mm ( $5/16$ " ) or 10 mm ( $3/8$ " ) line.
2. Deadend line to angled sheaves by reeving line downward and tying a stop knot in end of line.
3. Reeve line around end control sheave, around top sheave on windward mechanism, and out through cleat.
4. Tie stop knots on ends of lines so car will not be damaged if in an uncontrolled jibe.

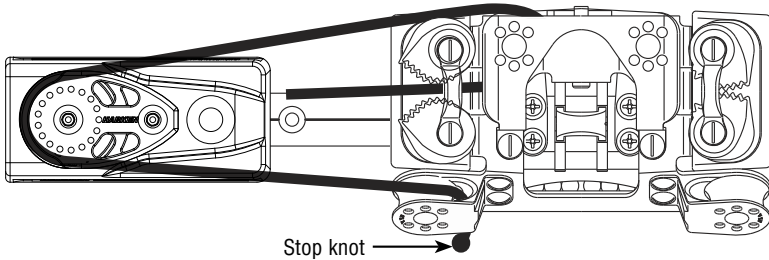

### Reeving 4:1 End Control

1. Use 8 mm ( $5/16$ " ) or 10 mm ( $3/8$ " ) line.
2. Splice or cow hitch eye to deadend eyestraps on top E2730 end control or to bail on 1631. If not used, deadend to eyestraps or becket of block.
3. Reeve line downward through angled sheave, around sheave at end of track, around top sheave on windward mechanism and out through cleat.
4. Tie stop knots on end of lines so car will not be damaged in an uncontrolled jibe.

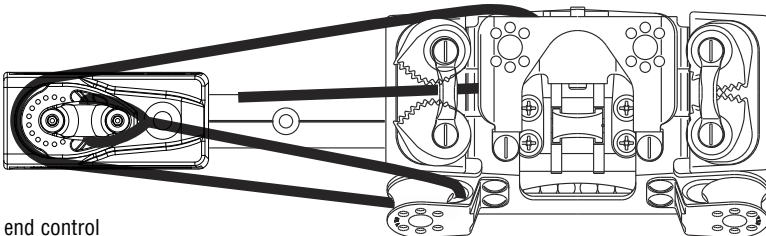

E2730 end control

## Using the Windward Sheeting Traveler Car

The windward sheeting car is much easier to use than to describe.

1. Position car by pulling windward traveler control line.
2. It is not necessary to release line from leeward cleat to pull car to windward.
3. When you tack, car stays in place until you pull it to windward. No need to release the leeward line.
4. If car is pulled to windward and then dropped back to the centerline before a tack, there will be slack in the leeward control line. When you tack, the car will drop below the centerline.

## Override Cleating for Slatting Conditions

If car releases uncontrollably during slatting conditions (large waves, little wind), it may be necessary to mount a Harken 150 cam cleat to deck near each end of traveler. Position cleats so traveler control lines can be cleated to override the windward mechanism and hold car in place.

## Mooring and Motoring

Tie the windward sheeting car completely to one side while motoring or when leaving the boat moored. Otherwise the car may work loose and be damaged when it hits track ends. You can also cleat the traveler lines in the override cleats as mentioned above.

## 1637 Midrange Adapter Kit for 1624/1625 Cars\*

\*Adapter kit also fits old-style cars with endcaps: 1508 and 1509.

1. Remove screws holding swivel ears or control blocks on top of car. Save screws.
2. Position windward adapter kit on car so angled sheaves face forward.
3. Put a few drops of blue Loctite® adhesive on screws and install in corresponding holes in the windward adapter kit. Tighten screws firmly.

## Replacement Parts

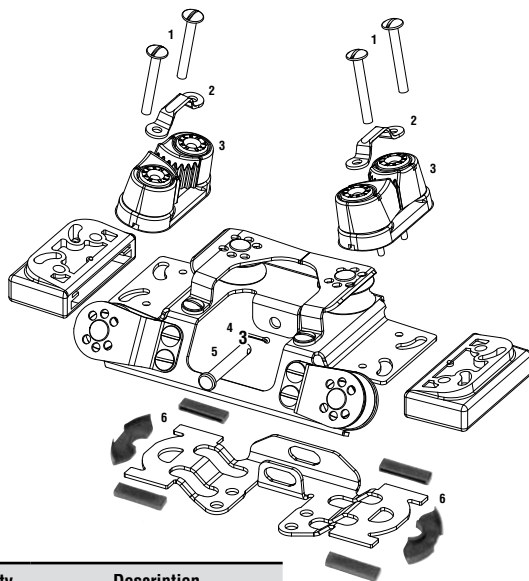

### Replacement Parts:

No.	Part No.	Qty	Description
1	HFS107	4	Trusshead screws 10-32X1.5"
2	201	2	Eyestraps
3	150SP* **	2	Cam cleats (special)
45	HFS118	1	Cotter pin
5	HCP507	1	Clevis pin
6	HCP218	1	Plastic slide set

\*Replacement kit (balls): Part No. 150BALLS;

\*\*Cam rebuild kit (parts/balls): Part No. 150KIT

Loctite is a registered trademark of Henkel AG & Company KGaA

## Installing Traveler Car on Track

Position car at end of track and gently roll on. Car should roll on easily, if not, check to make sure you are using CB track. **Do not remove ball retaining wires.** Cars will not roll unless they have retaining clips.

## Removing Ball Bearings from CB Cars



Position the car on edge and gently push one (1) ball at a time from the center of the retaining clip. **Do not remove the retaining clip from the car!**

## Loading Ball Bearings into CB Cars



Position car on edge with retaining clip in place. Gently push one (1) ball at a time into car from center of clip. Allow balls to roll into return race and insert remaining balls. **Do not overfill the car!**

### Ball Replacement Chart

CB car	Description	Car length	Balls/car	Balls	Order	Balls/set	Ball Ø
1635	Midrange CB	4 1/4" (108 mm)	48	Torlon®	1526	25	5/16" (8mm)
1636	Midrange CB/High-Load	5 3/16" (132)	60	Torlon	1526	25	5/16" (8mm)

## Attaching Splice

- Loosen one (1) endstop screw on end control. Remove other screw and rotate bail to capture splice loop. Install screws using a threadlocker such as blue Loctite® adhesive on screws.
- When using smaller control line, pass eye through bail and run tail through to make a hitch without undoing bail.

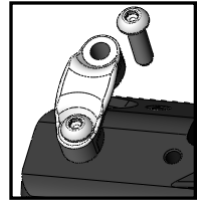

Loctite is a registered trademark of Henkel AG & Company KGaA.  
Torlon is a registered trademark of Solvay Advanced Polymers.

## CB + Cars can Convert to Fit Old-Style Non-CB Track

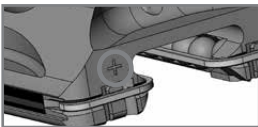

CB+ cars designed for CB track.



CB+ cars can convert to run on old-style, non-CB track.

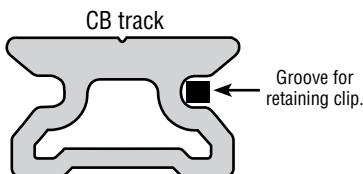

Track built after 2003. No need to convert car.

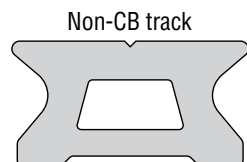

Track built before 2003.

## Converting CB + Cars to Run on Non-CB Track

**Important! Requires CB+ cars. See complete instructions at [www.harken.com/manuals](http://www.harken.com/manuals).**

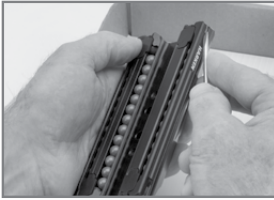

1. Use flat-bladed screwdriver to push retaining clip toward end.



2. Pry retaining clip off and dump balls in box.



3. Remove retaining clips and corner keepers over box to catch balls.



4. Hold car on edge and load lower side with correct number of balls. **DO NOT OVERLOAD.** Consult chart to confirm quantity.

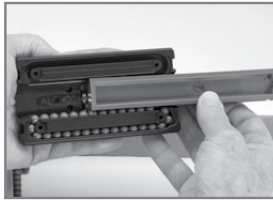

5. Remove two (2) clips from car loader. Slide car loader in so loading port is on the side of car without balls.



6. Put one (1) clip on "open" end of loader. Load rest of balls through ball loading port into empty bearing race. Consult chart to confirm quantity. Line up car loader with track and gently roll car onto track.

## Inspect

Frequently inspect shackles and control block fittings for signs of fatigue. Replace as necessary. Make sure every installation includes Harken track endstops. Arrange control tackle so cars do not hit endstops under load.

## Maintenance

**Traveler cars:** Clean by frequently flushing with fresh water. Periodically clean car by squirting a detergent/water solution into center openings. Roll car back and forth to distribute evenly. Flush bearings with fresh water.

Do not use spray lubricants because ball bearings can skid, not roll. Apply one (1) to two (2) drops of McLube® OneDrop™ ball bearing conditioner to ball contact surfaces of track. Roll car back and forth through OneDrop conditioner several times to distribute onto bearings. Wipe remaining OneDrop off track. OneDrop conditioner is preferred, but you can also use one (1) to two (2) drops of a light machine oil. Too much oil attracts dirt.

**Track:** Clean with detergent and water.

**Important! Exposure to some teak cleaners and other caustic solutions can result in discoloration of part and is not covered under the Harken warranty.**



## Warranty

For additional safety, maintenance, and warranty information see [www.harken.com/manuals](http://www.harken.com/manuals) or the Harken catalog.

McLube is a registered trademark of McGee Industries, Inc.

OneDrop is a trademark of McLube, a division of McGee Industries, Inc.

Printed in USA 4526 01/15